

PRX Series – Compact Switches

PRX-10, PRX-20, PRX-30, PRX-40, PRX-50, PRX-70

- Easy to install
- No standby power requirements
- Reliable for over 1 million cycles
- Interchangeable with existing sensors
- Hermetically sealed for longer performance

The PRX series from Gems offers a versatile line of low cost, general purpose proximity sensors designed for dry applications. Constructed out of ABS and UL approved material, the PRX series has no standby power requirements and no moving parts. Proximity sensors are hermetically sealed for long lasting performance and are easy to install for a variety of applications.

Specifications

Housing Material	ABS
Operating Temperature	32°F to 212°F (0°C to 100°C)
Switch	SPST, N.O.
Voltage, Max.	160 Vdc
Current, Max.	0.5 Amps
Vibration Resistance	10 to 55 Hz

Typical Applications

- General purpose
- Household appliances
- Security systems
- Door interlocks
- Safety interlocks
- Position indication
- Equipment automation

PRX-10

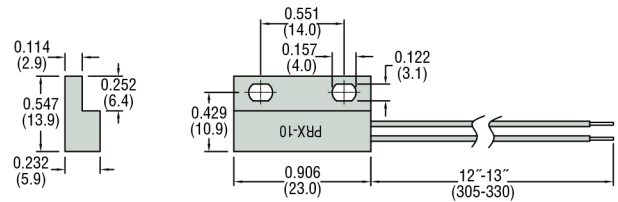

PRX-20

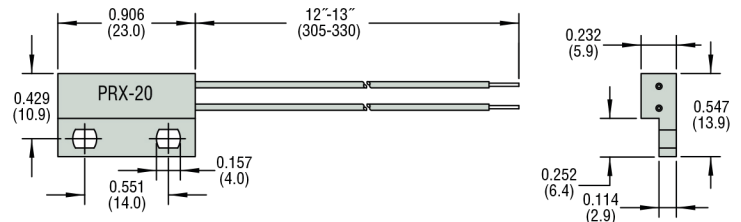

PRX-30

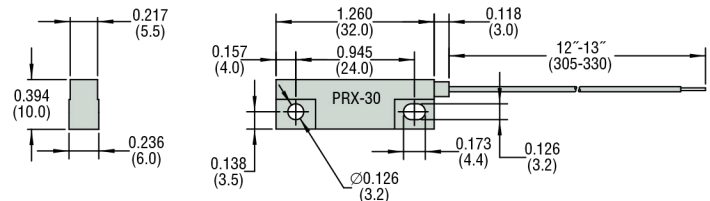

PRX-40

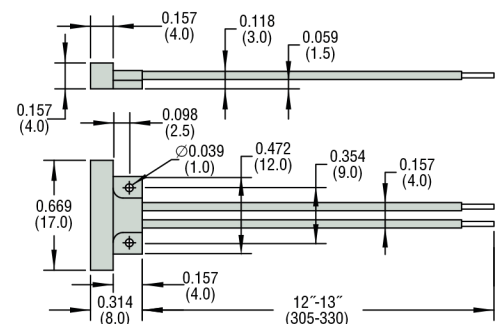
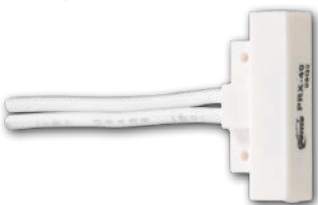

PROXIMITY SWITCHES

PRX-50

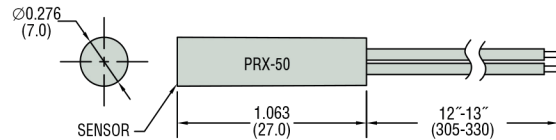

PRX-70

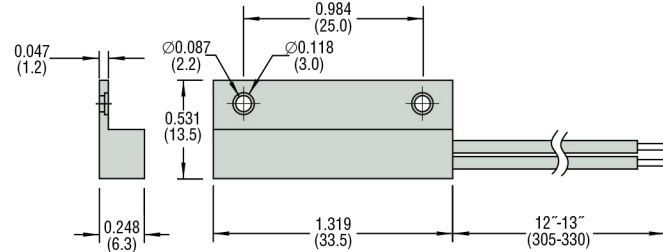

How To Order – Switches

Select by Part Number based on operational requirements. All proximity switches below come with matching magnets included.

Series	Operating Temperature	Contact Rating	Switch Open Distance, Max.	Switch Close Distance, Min.	Part Number
PRX-10	14°F to 176°F (-10°C to +80°C)	10 VA	1.18 inch (30 mm)	0.63 inch (16 mm)	225951
PRX-20	14°F to 176°F (-10°C to +80°C)	10 VA	1.18 inch (30 mm)	0.63 inch (16 mm)	225952
PRX-30	14°F to 176°F (-10°C to +80°C)	10 VA	1.18 inch (30 mm)	0.63 inch (16 mm)	225953
PRX-40	14°F to 176°F (-10°C to +80°C)	10 VA	0.79 inch (20 mm)	0.35 inch (9 mm)	225954
PRX-50	14°F to 140°F (-10°C to +60°C)	10 VA	1.38 inch (35 mm)	0.71 inch (18 mm)	225955
PRX-70	14°F to 140°F (-10°C to +60°C)	50 VA	1.02 inch (26 mm)	0.47 inch (12 mm)	225956

Notes:

- Product options include: Lead length, Activation Magnet and 22 Gage Wire. Please contact Gems for these options.
- Lead time 2 weeks. A minimum piece order is required; please contact factory .

Actuating Magnets

Ferrite

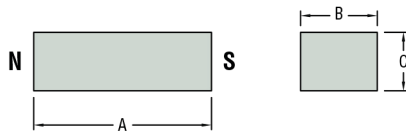

Neo

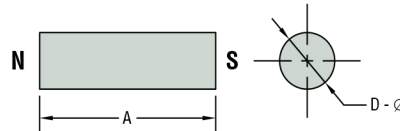

How To Order – Magnets

Magnets for the above Proximity Switch series can be ordered separately.

Specify Part Number based on series switch with which the magnet is to be paired.

Switch Series	Magnet Type	Dimensions – inch (mm)				Part Number
		A	B	C	D – Ø	
PRX-10 PRX-20 PRX-30	Ferrite	1 (25.5)	0.43 (11)	0.35 (9)	—	226618
PRX-40	Neo	0.62 (15.8)	—	—	0.11 (2.8)	226621
PRX-50	Neo	0.79 (20.1)	—	—	0.25 (6.3)	226622
PRX-70	Neo	1.13 (28.6)	—	—	0.18 (4.7)	226623

PRX-100 Series

Heavy Duty, General Purpose

- Easy to install
- No standby power requirements
- Reliable for over 1 million cycles
- Interchangeable with existing sensors
- Hermetically sealed for longer performance

Specifications

Housing Material	Noryl™ (PPO)
Operating Temperature	-40°F to +194°F (-20°C to +90°C)
Pressure	Atmospheric
Approvals	cULus File # E305671

Typical Applications

- General Purpose
- Household Appliances
- Security systems
- Door interlocks
- Safety interlocks
- Position indication
- Equipment automation

How To Order – Two Steps: Select Switch and Magnet

Step 1: Configure Switch Part Number from options below.

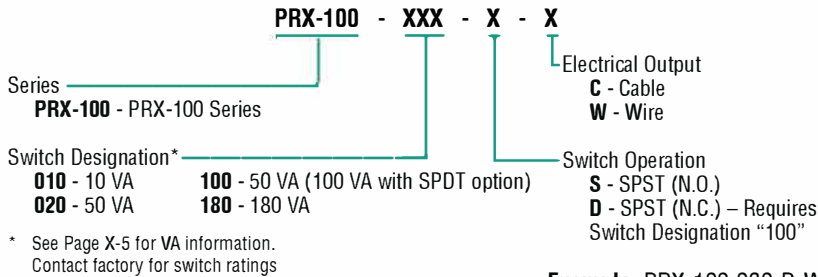

Example: PRX-100-020-D-W

Step 2: Select an Actuating Magnet to pair with Switch.

PRX-100 Series actuating magnets are available in both housed assemblies and as bare magnets (See Page K-5).

Configuration

Type 1 Assembly

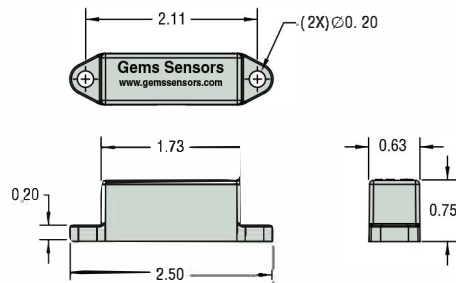

Type 2 Assembly

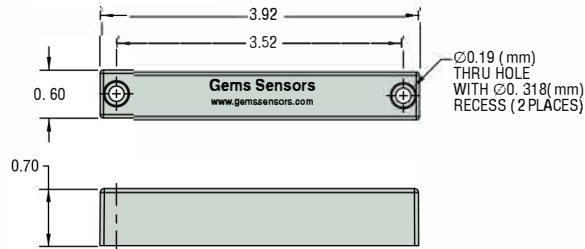

How to Order

Magnets for the above Proximity Switches are ordered separately.
Select by Configuration, Magnet Type and Size.

Configuration	Magnet Type	Magnet Size		Part Number
		A – Length	B – Diameter	
Type 1 Assembly	Alnico 5	1.5" (38.1 mm)	3/8" (9.5 mm)	217302
	Neo N35H	1.5" (38.1 mm)	3/8" (9.5 mm)	217310
Type 2 Assembly	Alnico 5	2.5" (63.5 mm)	3/8" (9.5 mm)	217301
	Alnico 5	1.5" (38.1 mm)	3/8" (9.5 mm)	222055
	Neo N35H	1.5" (38.1 mm)	3/8" (9.5 mm)	222056



Dimensions

Type C – Cable Output

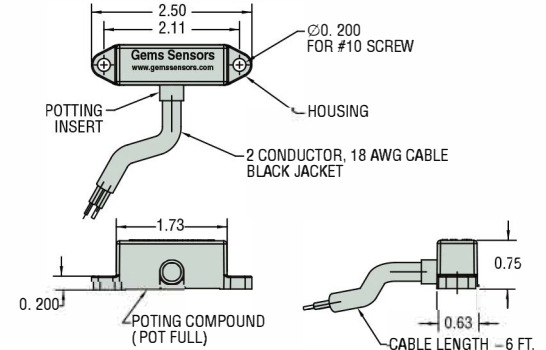

Type W – Wire Output

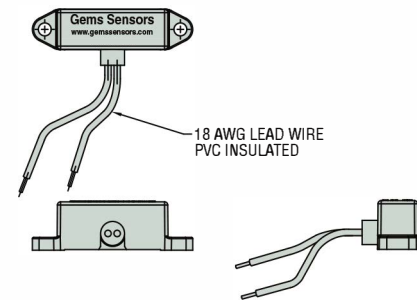

PRX-300 Series

Mid Range General Purpose

- Stress relief technology for reed switch protection
- Easy to install
- No standby power requirements
- Reliable for over 1 million cycles
- Interchangeable with existing sensors
- Hermetically sealed for longer performance
- Normally Open (No magnetic field)

The compact size of the PRX-300 series offers a variety of low cost, high performance proximity switches. Constructed out of robust 33% glass filled nylon the PRX-300 series has no standby power requirements and no moving parts. Proximity switches are hermetically sealed for long lasting performance and are easy to install and adjust for a variety of customer applications.

Specifications

Housing Material	Nylon 33% GF
Operating Temperature	32°F to 212°F (0°C to 100°C)
Pressure	Atmospheric
Switch	SPST, N.O.
Voltage, Max.	250 Vdc
Current, Max.	1.0 A
Approval	U.L. Recognized

Typical Applications

- General Purpose
- Household Appliances
- Security systems
- Door interlocks
- Safety interlocks
- Position indication
- Equipment automation

PRX-300

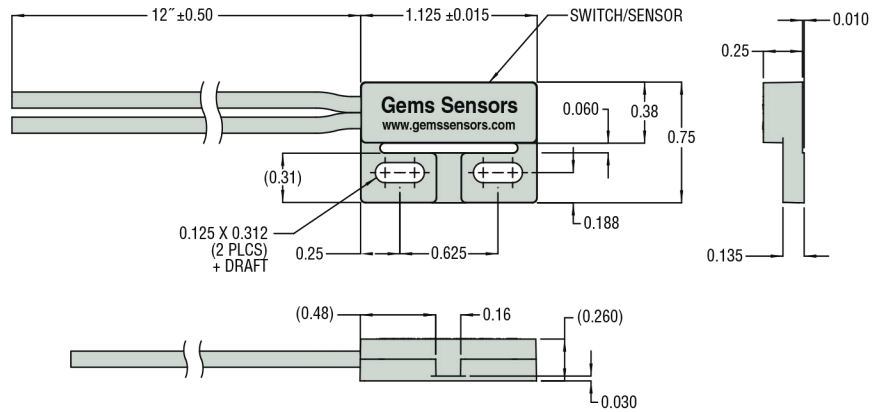

PRX-310

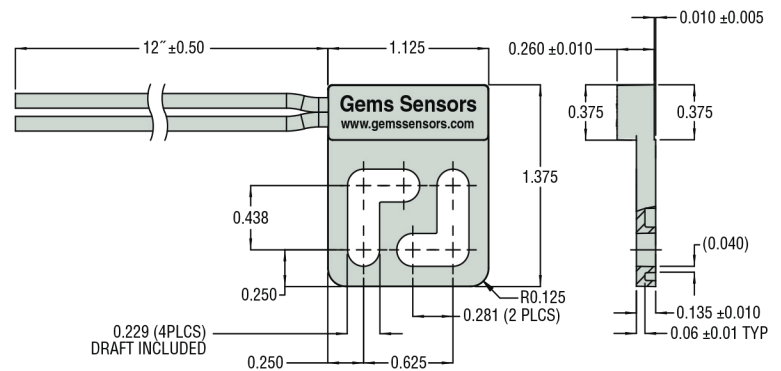

PRX-320

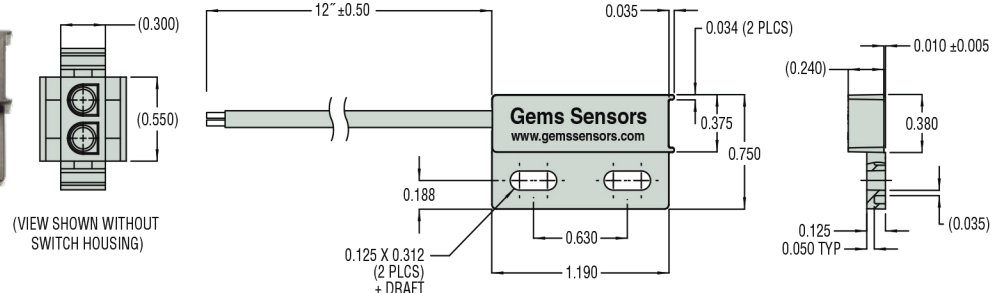

How To Order – Switches

Select by Part Number based on operational requirements.

Series	Housing Material	Operating Temperature	Contact Rating	Switch Actuation Distance	Part Number
PRX-300	Nylon 33% GF	32°F to 212°F (0°C to 100°C)	50 VA	0.75 inch (19 mm)	225815
PRX-310	Nylon 33% GF	32°F to 212°F (0°C to 100°C)	50 VA	0.70 inch (17.8 mm)	225820
PRX-320	Nylon 33% GF	32°F to 212°F (0°C to 100°C)	50 VA	0.5 inch (12.7 mm)	225830

Notes:

- Product options include: Lead length, Activation Magnet and 22 Gage Wire. Please contact Gems for these options.
- Lead time 2 weeks.

Actuating Magnets

Bare Magnet

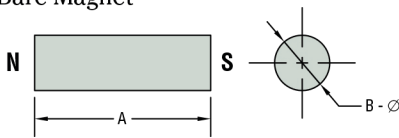

How to Order

Magnets for the above Proximity Switches series are ordered separately.

Select by Configuration, Magnet Type and Size.

Configuration	Magnet Type	Magnet Size		Part Number
		A – Length	B – Diameter	
Bare Magnet	Alnico 5	1" (25.4 mm)	3/16" (4.8 mm)	217311
		1.5" (38.1 mm)	3/8" (9.5 mm)	217303
		2.5" (63.5mm)	3/8" (9.5 mm)	217909
		3" (76.2mm)	1/2" (12.7 mm)	220551
	Neo N35H	1" (25.4 mm)	3/16" (4.8 mm)	217304
				217309
		1" (25.4 mm)	3/8" (9.5 mm)	220999
		1.5" (38.1 mm)	3/8" (9.5 mm)	220753